

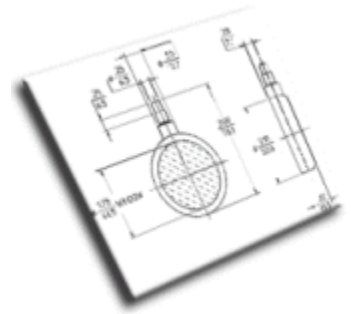

Radiation Survey Meter – How it Works

Detecting Radiation

Radiation can be detected using a variety of instruments and methods that read out in exposure or count rate. The measuring device used is dependent upon the type of radiation and the measurement needed. The three basic methods employed involve the use of survey instruments, liquid scintillation counters and dosimetry. This section discusses the operation of the two most common types of survey instruments used for the detection of ionizing radiation.



Survey Instruments

Survey instruments locate contamination or detect radioactive material. Radioactive material detected in the attached probe causes electronic pulses that move the meter needle and make an audio response. The meters read out in counts per minute (cpm) and can be calibrated to report mR/hr. There is a large selection of survey instruments available, designed for the detection of a specific type of radiation. One of the most common survey meters, shown here, can be used with various probes, depending on your needs and radionuclide. Before using a survey meter, make sure you have the right probe, such as pancake ([Geiger Mueller](#)) or scintillation ([Sodium-Iodide](#)) Probe.



General Purpose Survey Meter (Scaler)

GM Probe with Survey Meter



The GM Probe has a simple construction. Just under the surface, you can see a gas filled chamber connected to a simple circuit. Radiation interacts in the chamber and is changed into an electronic pulse.

Laboratory Safety

46 Blackstone Street, Cambridge, MA 02139 | T: 617.496.3797 | F: 617.496.5509

www.ehs.harvard.edu | email: lab_safety@harvard.edu



The screen protects the thin-film window from breakage, scratches, or puncture.

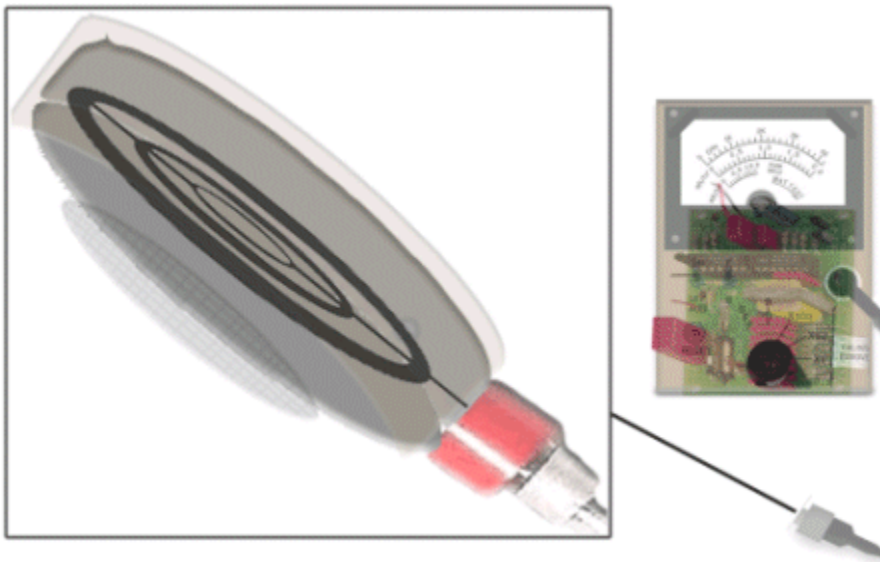

Inside the chamber, you can see a "target" shaped electrode called an anode. This electrode collects the charge created by ionization from incident radiation. The electric circuit is completed by using the chamber wall as the cathode. The chamber is filled with a special gas that amplifies the signal after the ionization. The amplification means that an interaction is counted but does not directly relate to the radiation dose.

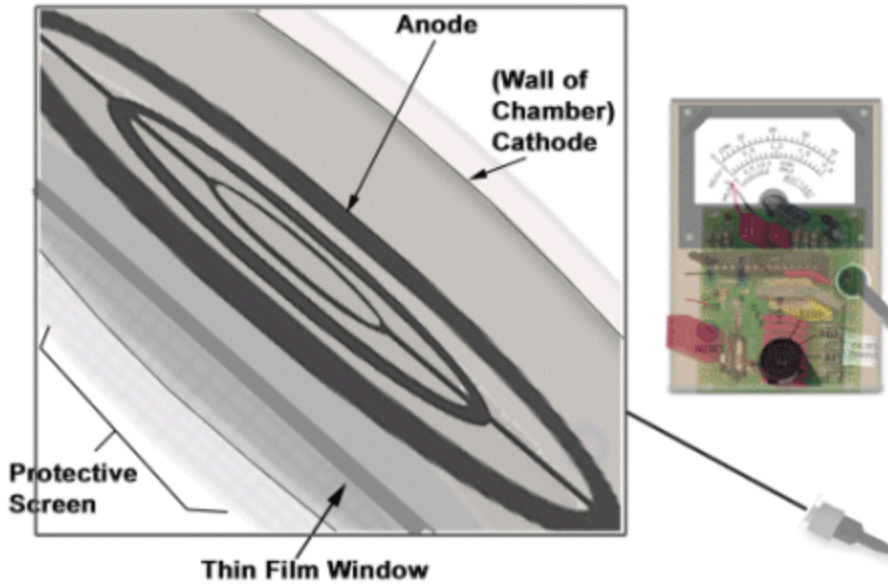

Looking closer, we can see the interior chamber where the interaction will occur.

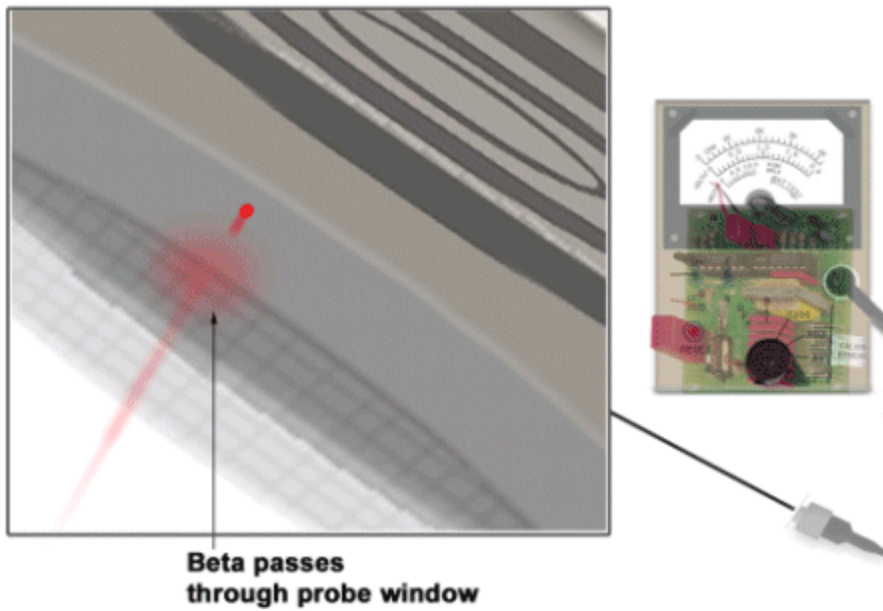

Incident radiation, shown as a beta particle, passes through the thin window of the probe and into the gas filled chamber.

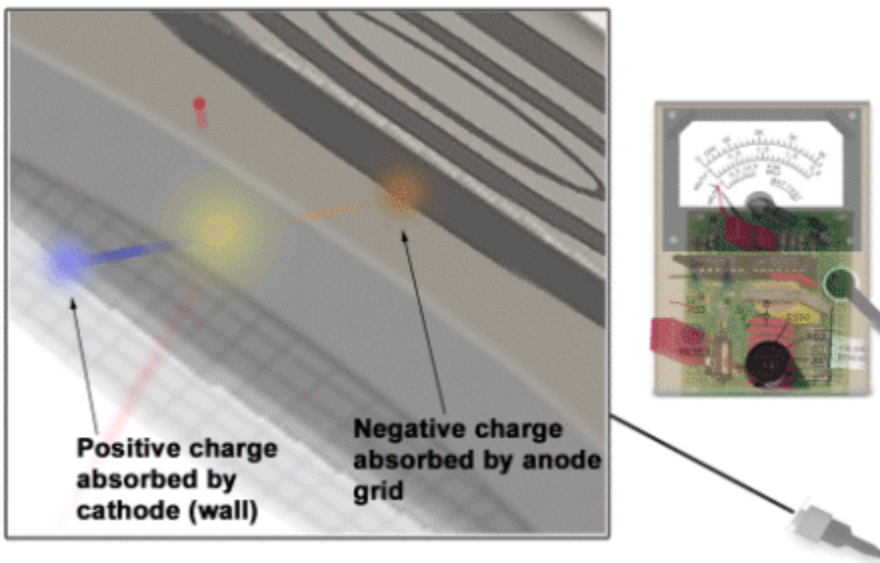
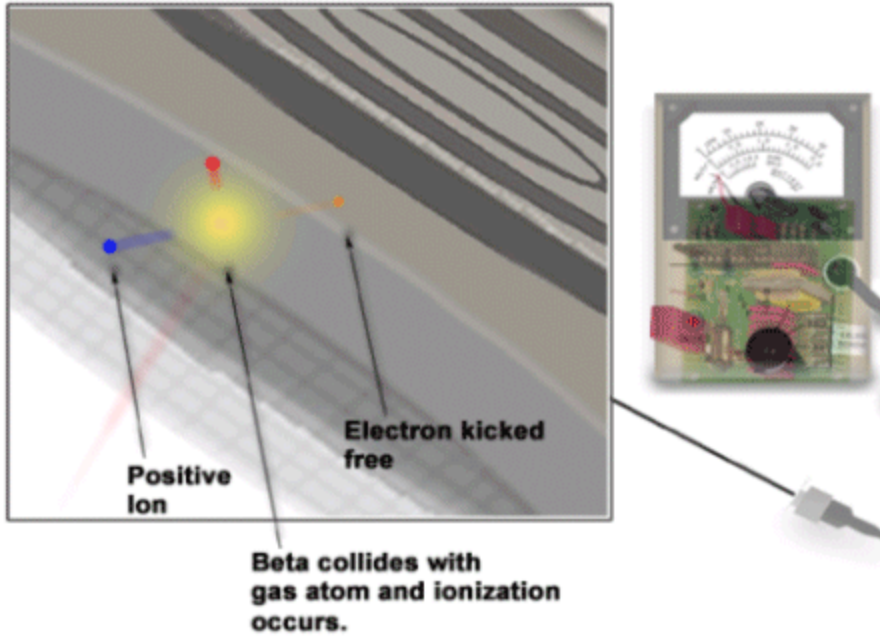

The two charges created by the ionization continue to move towards the electrodes as the beta keeps going through the chamber. The two charges then strike the electrodes and a potential forms.

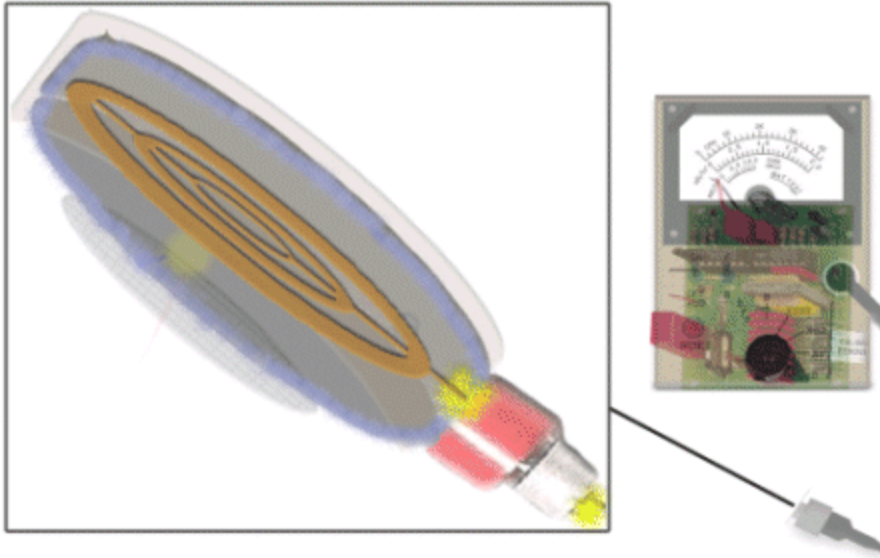

The ionization creates an electric current in the circuit. The chamber's quench gas stops the amplification from an interaction (approximately 80 microseconds) and prepares the chamber for another interaction.

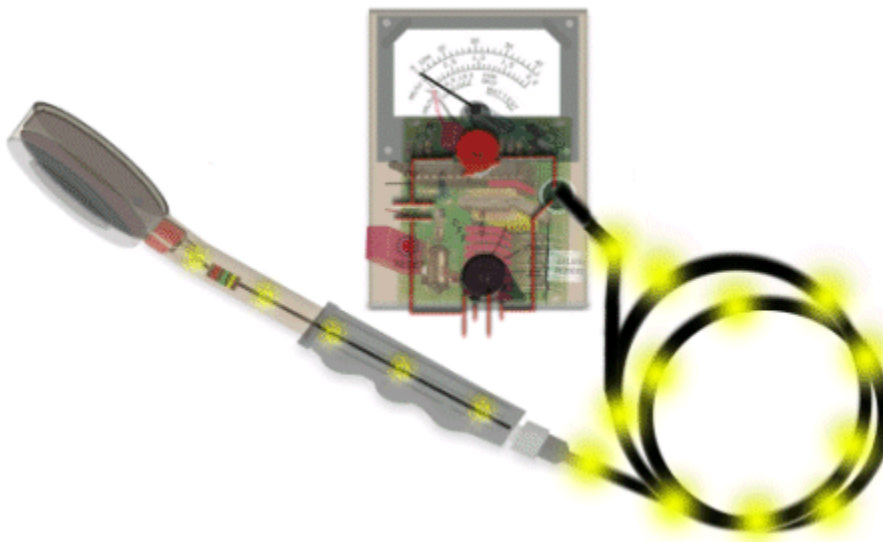

The electric current is processed in the scaler and sorts out the radiation interaction current pulses from the system current from the batteries.



Inside the scaler, the signals are reported visually by a meter (needle) and audibly by clicks.

Scintillation (NaI) Probe w/ Survey Meter



A scintillation probe is based on the light emission by substances (i.e. a crystalline sodium-iodide salt called NaI) that emits light or "scintillates" when struck by ionizing radiation). These light flashes are collected by a photomultiplier tube, which also amplifies the signal. These sensitive components are all encased in a magnetically shielded, light tight aluminum shell. This probe is used to primarily detect low energy photons (^{125}I) and low energy x-rays.

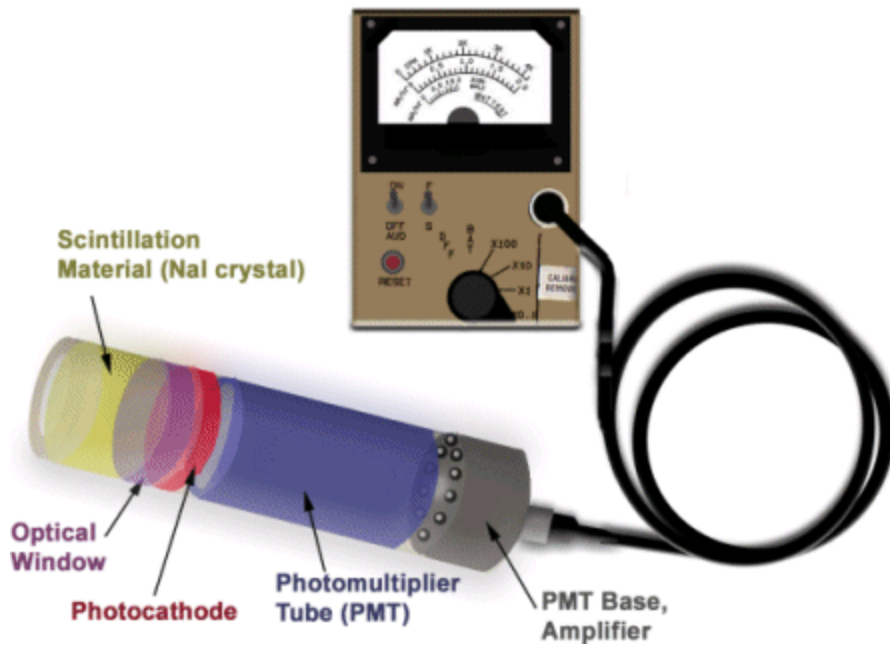

The probe contains a scintillation material (a NaI crystal), an optical window, a photocathode, a photomultiplier, and an amplifier.

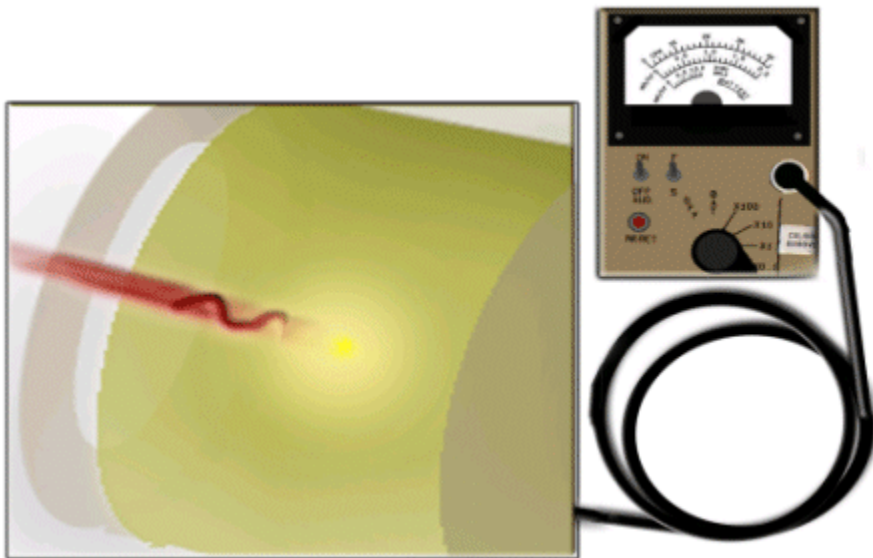

An incident X-ray or gamma ray passes through the probe window depositing energy in the scintillation crystal. The scintillation material converts the energy into light (scintillates).

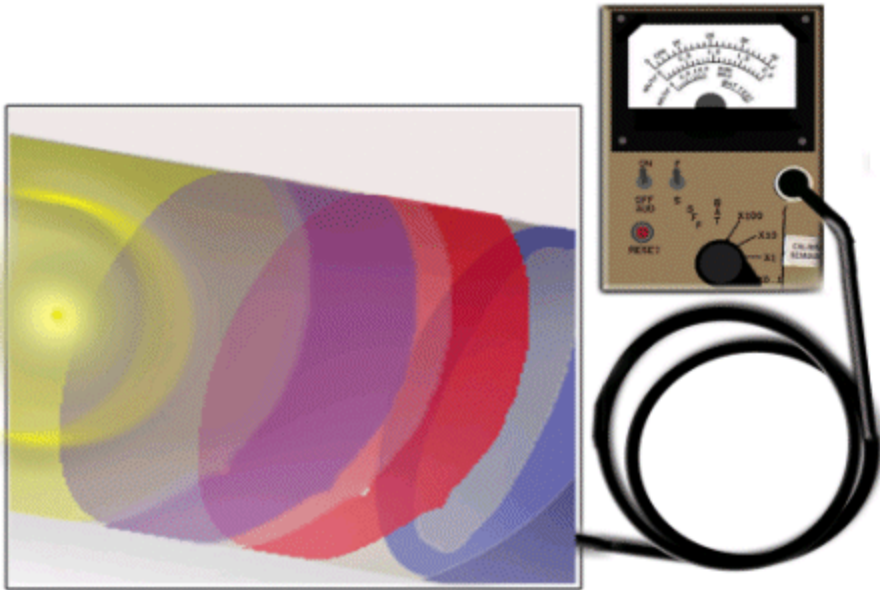

The emitted light spreads out and strikes the optical window and is transferred to the photomultiplier (PMT).

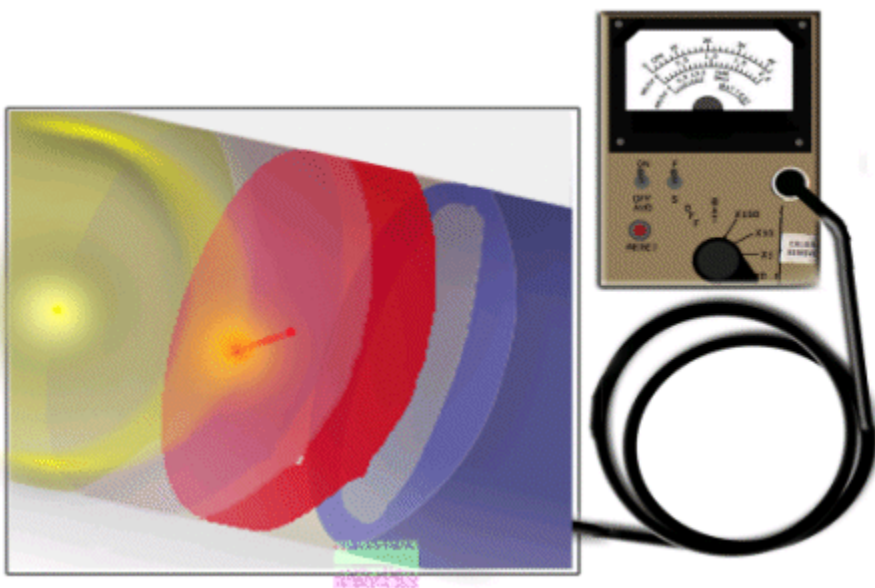

At the front of the (PMT) is a window of special material called the photocathode (shown in red). When light strikes the photocathode, it produces electrons. One electron is shown ejected. The electron is pulled towards the PMT.

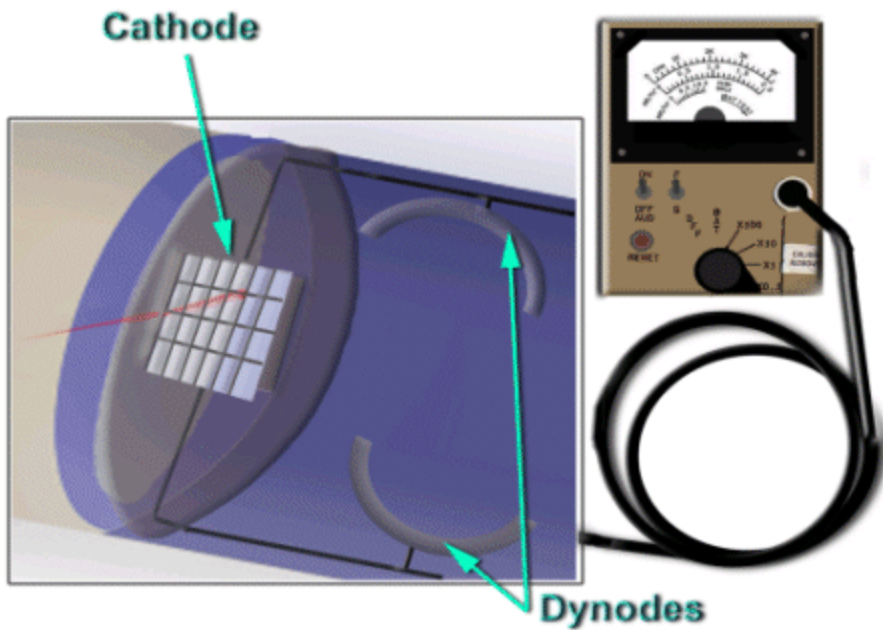

The electron ejected from the photocathode passes into the photomultiplier.

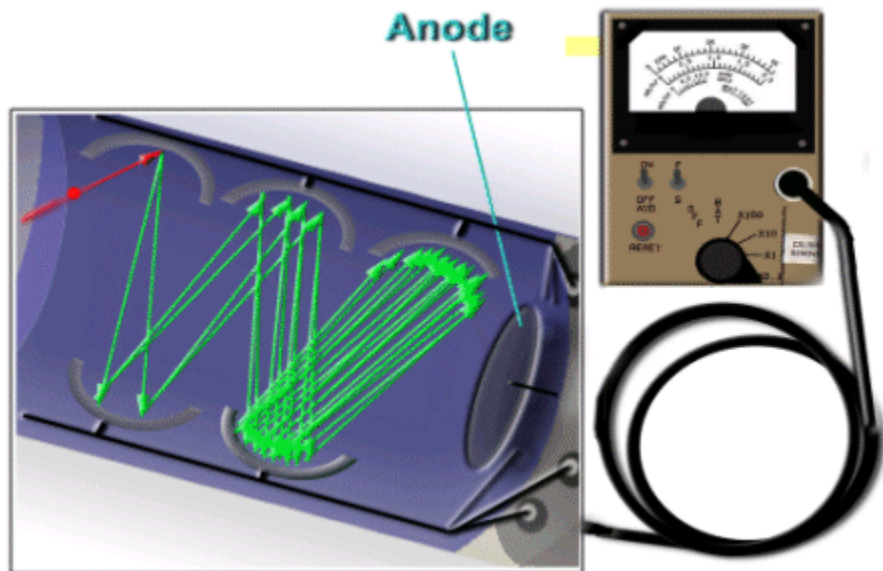

The ejected electron hits the PMT's dynodes and multiplies the number of electrons. This essentially causes an "avalanche" of electrons that result in an amplification of the original interaction.

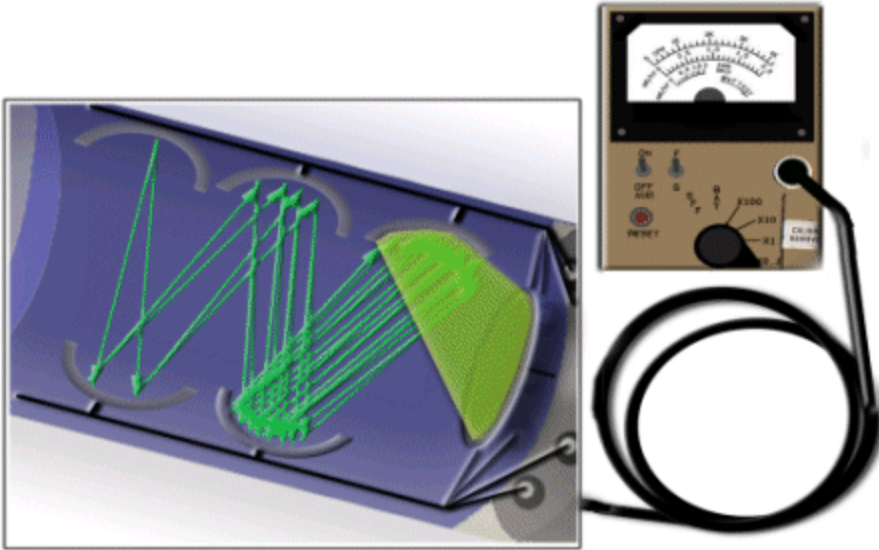

The avalanche ends at the last dynode, where an electron pulse that is millions of times larger than it was at the beginning. The electrons are then collected by an anode at the end of the tube.

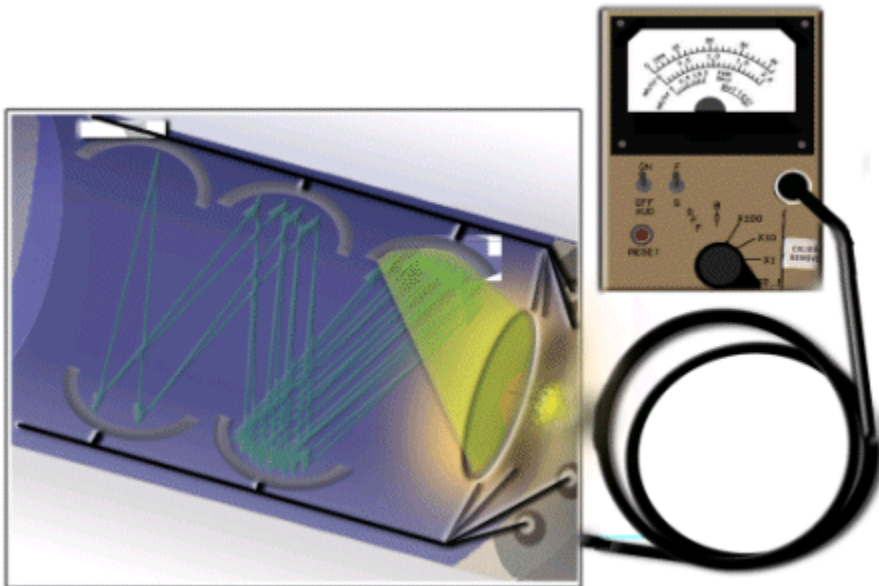

The anode collects the electrons and forms an electronic pulse.

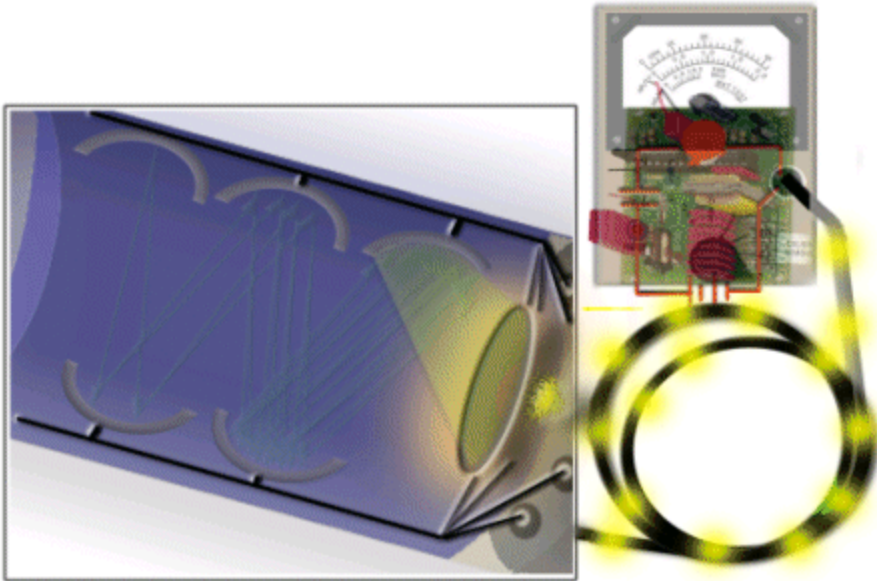

The pulse is directed along the circuit to the scaler as a series of pulses.

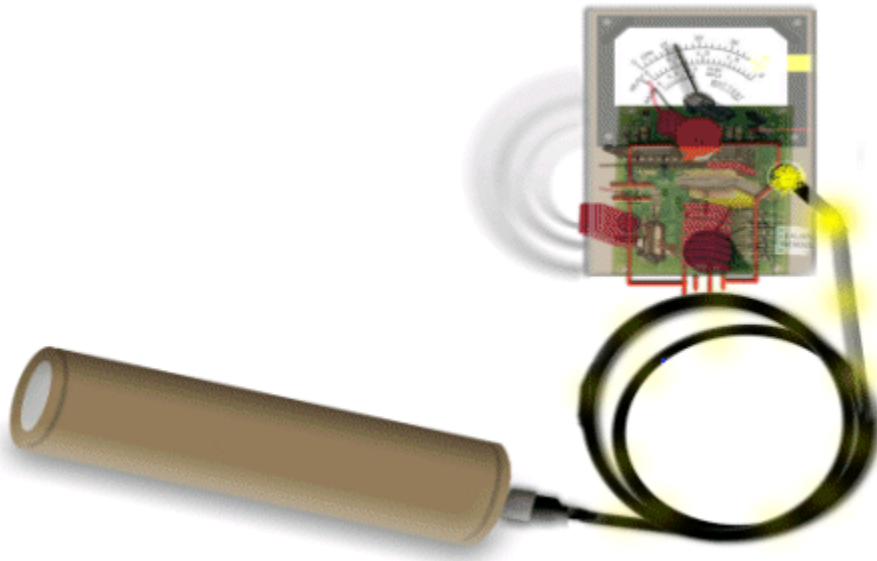

Inside the scaler, the signals are reported visually by a meter (needle) and audibly by clicks.